

FLUME DOUBLE WALL LIGHT

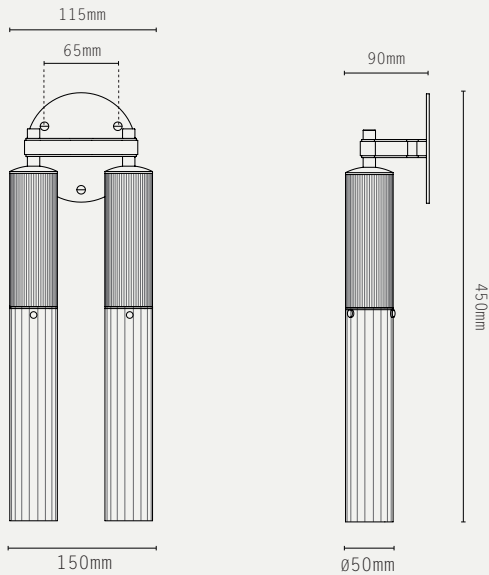

LIGHT SOURCE:

GU10 LAMP BASE
(12W MAX LED ONLY / 35MM MAX
LAMP DIAMETER)

LAMP SUPPLIED:

2 X GU10 MR11 LED/ 2700K /
3.6W / 290 LUMENS

DIMMABLE:

PHASE (MAINS) DIMMING (USING
SUPPLIED LAMP)

VOLTAGE:

240V AC (CLASS I)

CERTIFICATIONS:

CE / UKCA

MATERIALS:

BRASS, GLASS

WEIGHT:

3 KG (APPROX)





OPTIONAL ACCESSORIES:

- DEEP MOUNTING BACKBOX
- EU JUNCTION BOX ADAPTOR



ADDITIONAL INFO:

DESIGNED BY WILL EARL 2019
MADE IN ENGLAND

METAL FINISHES:

-  ANTIQUE BRASS
-  BRONZE
-  SATIN BRASS
-  SATIN NICKEL

GLASS OPTIONS:

-  CLEAR REEDED GLASS
-  FROSTED REEDED GLASS

PRODUCT CODES:

FL.DW.AB.CRG - ANTIQUE BRASS / CLEAR REEDED GLASS
FL.DW.BZ.CRG - BRONZE / CLEAR REEDED GLASS
FL.DW.SB.CRG - SATIN BRASS / CLEAR REEDED GLASS
FL.DW.SN.CRG - SATIN NICKEL / CLEAR REEDED GLASS

FL.DW.AB.FRG - ANTIQUE BRASS / FROSTED REEDED GLASS
FL.DW.BZ.FRG - BRONZE / FROSTED REEDED GLASS
FL.DW.SB.FRG - SATIN BRASS / FROSTED REEDED GLASS
FL.DW.SN.FRG - SATIN NICKEL / FROSTED REEDED GLASS

FLUME DOUBLE WALL LIGHT - IP44

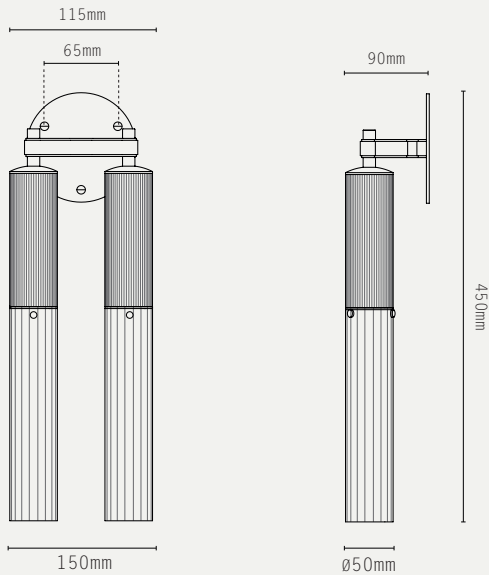

LIGHT SOURCE:

GU10 LAMP BASE
(12W MAX LED ONLY / 35MM MAX
LAMP DIAMETER)

LAMP SUPPLIED:

2 X GU10 MR11 LED/ 2700K /
3.6W / 290 LUMENS

DIMMABLE:

PHASE (MAINS) DIMMING (USING
SUPPLIED LAMP)

VOLTAGE:

240V AC (CLASS I)

CERTIFICATIONS:

CE / UKCA
IP44

MATERIALS:

BRASS, GLASS

WEIGHT:

3 KG (APPROX)





OPTIONAL ACCESSORIES:

- DEEP MOUNTING BACKBOX
- EU JUNCTION BOX ADAPTOR



ADDITIONAL INFO:

DESIGNED BY WILL EARL 2019
MADE IN ENGLAND

METAL FINISHES:

-  ANTIQUE BRASS
-  BRONZE
-  SATIN BRASS
-  SATIN NICKEL

GLASS OPTIONS:

-  CLEAR REEDED GLASS
-  FROSTED REEDED GLASS

PRODUCT CODES:

FL.DW.IP.AB.CRG - ANTIQUE BRASS / CLEAR REEDED GLASS
FL.DW.IP.BZ.CRG - BRONZE / CLEAR REEDED GLASS
FL.DW.IP.SB.CRG - SATIN BRASS / CLEAR REEDED GLASS
FL.DW.IP.SN.CRG - SATIN NICKEL / CLEAR REEDED GLASS

FL.DW.IP.AB.FRG - ANTIQUE BRASS / FROSTED REEDED GLASS
FL.DW.IP.BZ.FRG - BRONZE / FROSTED REEDED GLASS
FL.DW.IP.SB.FRG - SATIN BRASS / FROSTED REEDED GLASS
FL.DW.IP.SN.FRG - SATIN NICKEL / FROSTED REEDED GLASS